

LTFL-106-2A3

Specifications

90W Factory light

W

Eco-friendly product
No Mercury, No Lead (RoHS standard)



5,000K

Total Flux	6,250lm±10%
Efficiency	>69lm/W
Power Consumption	90W±10%
Input Power	90~240 Vac (50/60Hz)
PF (Power Factor)	>0.90
Color Rendering Index	Ra>70
Operation temp.	-30~50°C
Storage temp.	-40~80°C
Beam Angle	156°
Housing & Lampshade	Alluminum Alloy & PC
Protection Rating	IP 65
Weight	5.8 kg
Working Life	>40,000 hrs
Figuration Size	Ø310 x 254 mm



Dimension

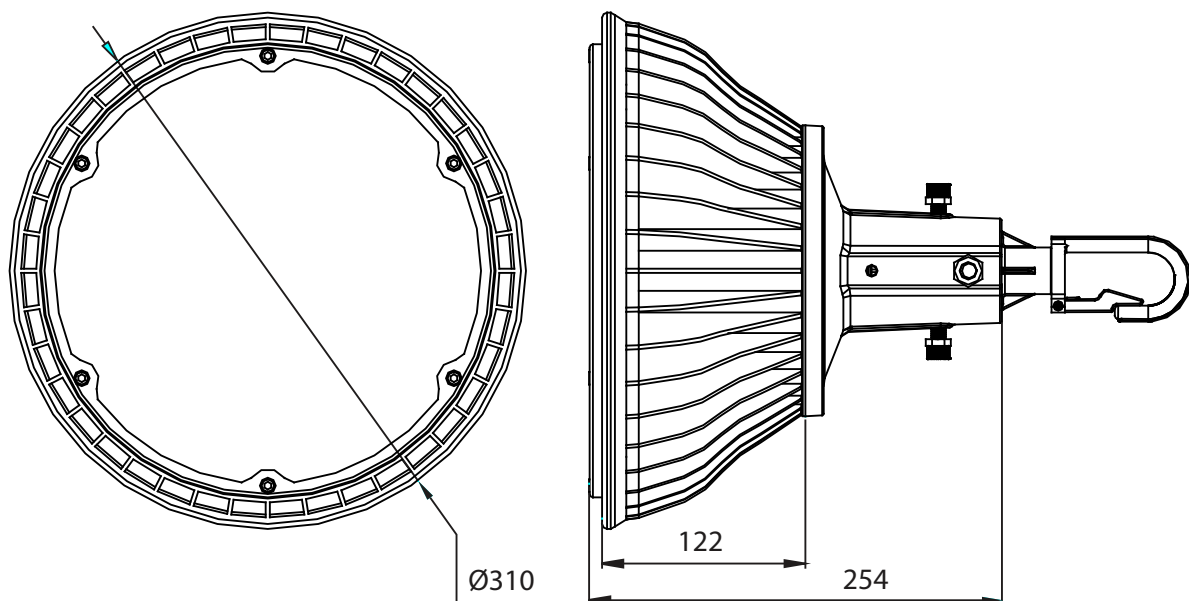

246 Kumho-ri Buyong-myeon, Cheongwon-gun, Chungcheongbuk-do, Korea, 363-942
Tel: +82-70-4331-3570 Fax: +82-43-263-3308